

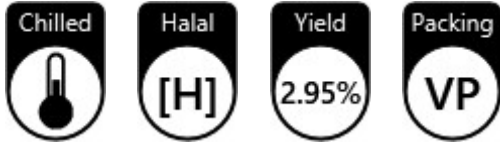

24868 - PS-CUBE ROLL 7R 2.5-5.5KG OV VP CH - HQB



Edible

Scheduling Group	SG1
Market Group	MG2 EU
Eligible For Sale To	Belgium, Cyprus, Denmark, European Union, Faroe Islands, Germany, Gibraltar, Italy, Netherlands, Portugal, Slovakia, Spain, United Kingdom
Halal Status	Halal Only
Specification	B32 CUBE ROLL LIP OFF
Cut From Grades	PS (Premium Steer/Heifer)
Attribute	High Quality Beef
pH	< 5.80
Spinal Cord	Removed
Bone	Boneless

Images



Quality Points

QP 1	Ends to be square
QP 2	Bone chips and cartilage removed
QP 3	No muscle separation at the chuck end

Weights

		Metric		Imperial	
		Min	Max	Min	Max
Min/Max Weight		2.5kg	5.5kg	5.51lb	12.13lb
Pieces Per Pack	1				
Catch Weight (Kg)		10kg	22kg	22.05lb	48.5lb
Packs Per Carton	4				

Presentation



Orientation

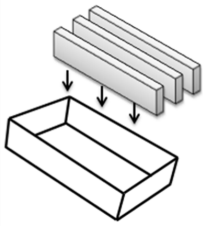

Soldier Pack Lengthways

Packs placed standing side by side on their ends lengthways in the carton

Labelling

100-120mm Machine erected/glued





100-120mm Manual non-glued



Beef EU Multi ADD 100-120 Ctn

- Placement on TOP panel adjacent to 'Safe Handling Instructions'
- Label must be placed neatly, be firmly attached and must not obscure any other information
- Clear space must be left on End panel for USDA import approval stamp, shipping mark & carton seal

Bill of Materials

Description	Nav Code	Design No	Packs	Mult	Qty	Total Tare		Total
						Tare		
 V/BAG SFB2571 BEEF LGD 250X710 50UM A600	N29123	SFB2571.	4	1	4			
 CTN BASE B120CH PLAIN 508X328X120 P-TEX	N25607	B120CH	1	1	1			
P/LINER 222 540440550 20UM POR	N25638	DES222	1	1	1			
CTN LID SF50P 52733949 SFF PREMIUM BEEF NO FLAPS	N26781	SF50P	1	1	1			

Labels

Foreign Code	MULTIB 415
Chilled Expiry	120 Days
Expiry Calculated By	Slaughter Date
Graphics	B-EUCH-F, EU9-CH-A, HAL-NZ-R



Pack

Type Adhesive
 Stock N28386 Blank Pack Lbl 90100 All Species
 Format BEEF MULTI EU-USA CH CUT

EU OFFICE: SILVER FERN FARMS (UK) LTD
 CAMBRIDGE ROAD, NEWMARKET - CB8 0TN - U.K.

BONELESS BEEF
 PS-RIBEYE ROLL
 PRODUCT OF NEW ZEALAND
 ØKSEKØD RIBEYE FILET
 BOEUF NOIX D'ENTRECÔTE
 RINDER RIBEYE
 COSTATA DI BOVINO ADULTO
 LOMO ALTO DE VACUNO

ORIGIN - NEW ZEALAND

KEEP REFRIGERATED - RECOMMENDED STORAGE TEMP -1°C
 RECOMMENDED DISTRIBUTION TEMP: 0°C to 2°C

SLAUGHTERED IN NEW ZEALAND: ME### LOT No.: BZ181
 CUTTING IN NEW ZEALAND: ME###

PRODUCTION/SLAUGHTER DATE: 30 JUN 2018
 PACK DATE: 01 JUL 2018

NOT SUITABLE FOR RAW USE BY: 28 OCT 2018

CONSUMPTION. COOK THOROUGHLY

DKK Oprindelsesland: New Zealand • Fersk • Slagtedato = Slaughter date • Pakkedato = Pack date • Bedst far = Use by • Anbefalet opbevaringstemperatur = Recommended storage temperature • Ikke egnet til at spise rå. Gennemsteget grundigt. • Netto vægt = Net weight

FRA Origine: Nouvelle-Zélande • Frais • Lieu d'abattage / Lieu découpe: Nouvelle-Zélande = ME N° • Date d'abattage = Slaughter date • Date d'emballage = Pack date • À consommer jusqu'au = Use by • Température recommandée de conservation = Recommended storage temperature • Ne pas consommer cru. Cuire à coeur. • Poids net = Net weight

DEU Herkunft: Neuseeland • Frisch • Schlachtdatum = Slaughter date • Verpackungsdatum = Pack date • Verfallsdatum = Use by • Empfohlene Lagertemperatur = Recommended storage temperature • Nicht für den Rohverzehr geeignet. • Vollständig durchgaren. • Nettogewicht = Net Weight

ITA Origine: Nuova Zelanda • Prodotto fresco • Data di produzione = Slaughter date • Data di confezionamento = Pack date • Da consumarsi entro = Use by • Temperatura consigliata per la conservazione = Recommended storage temperature • Non adatto al consumo a crudo. Cuocere accuratamente. • Peso netto = Net weight

ESP Origen: Nueva Zelanda • Refrigerado • Fecha de sacrificio = Slaughter date • Fecha de envasado = Pack date • Fecha de caducidad = Use by • Temperatura de conservación recomendada = Recommended storage temperature • No apto para su consumo en crudo. Cocinar completamente. • Peso neto = Net weight





Carton

Stock N25863 HALLY Blank 13090 CTN LBL

Format BEEF MULTI EU-USA CH CTN

SILVER FERN FARMS LIMITED, DUNEDIN, NEW ZEALAND www.silverfernfarms.com

BONELESS BEEF
PS-RIBEYE ROLL
PRODUCT OF NEW ZEALAND
OKSEKØD RIBEYE FILET
BOEUF NOIX D'ENTRECÔTE
RINDER RIBEYE
COSTATA DI BOVINO ADULTO
LOMO ALTO DE VACUNO

WEIGHT RANGE:
5.5-12.1lb / 2.5-5.5kg

[H]

SLAUGHTERED IN NEW ZEALAND: ME###
CUTTING IN NEW ZEALAND: ME###

ORIGIN: NEW ZEALAND
KEEP REFRIGERATED

RECOMMENDED STORAGE TEMP -1°C
RECOMMENDED DISTRIBUTION TEMP: 0° TO 2°C

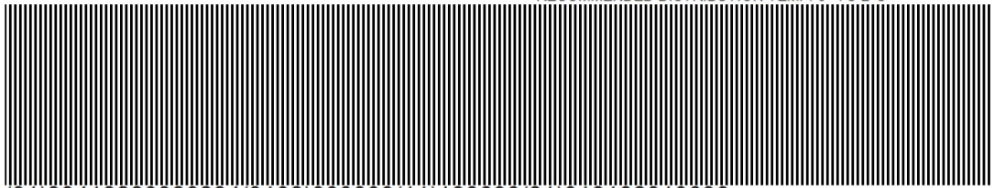

(01)99418220326284(3102)000000(11)180630(21)018182013636

Prepared by: ME###
Silver Fern Farms Limited
- Dunedin, 283 Princes
Street, Dunedin

PRODUCTION/SLAUGHTER DATE: 30 JUN 2018

PACK DATE: 01 JUL 2018

USE BY: 28 OCT 2018

LOT No.: BZ181

NET WEIGHT:

0.0lb
0.00kg

C24868

01 3636
90 0000HR
SUPER
ORDER



EU OFFICE: SILVER FERN FARMS (UK) LTD, CAMBRIDGE ROAD, NEWMARKET - CB8 0TN - U.K.

Additional 1

Stock N25863 Ctn LBL (Horizontal View)

Format ALL SPECIES MULTI CH ADD

C

DNK	Oprindelsesland: New Zealand • Fersk • Slagtedato = Slaughter date • Pakkedato = Pack date • Bedst før = Use by • Anbefalet opbevaringstemperatur = Recommended storage temperature • Ikke egnet til at spise rå. Gennemsteges grundigt. • Netto vægt = Net weight.
NLD	Herkomst: Nieuw-Zeeland • Vers • Slachtdatum = Slaughter date • Verpakkingsdatum = Pack date • Te gebruiken tot = Use by • Aanbevolen bewaartemperatuur = Recommended storage temperature • Niet rauw eten. Goed doorkoken. • Nettogewicht = Net weight.
FRA	Origine: Nouvelle-Zélande • Frais • Date d'abattage = Slaughter date • Date d'emballage = Pack date • À consommer jusqu'au = Use by • Température recommandée de conservation = Recommended storage temperature • Ne pas consommer cru. Cuire à coeur. • Poids net = Net weight.
DEU	Herkunft: Neuseeland • Frisch • Schlachtdatum = Slaughter date • Verpackungsdatum = Pack date • Verfallsdatum = Use by • Empfohlene Lagertemperatur = Recommended storage temperature • Nicht für den Rohverzehr geeignet. Vollständig durchgaren. • Nettogewicht = Net Weight.
ITA	Origine: Nuova Zelanda • Prodotto fresco • Data di produzione = Slaughter date • Data di confezionamento = Pack date • Da consumarsi entro = Use by • Temperatura consigliata per la conservazione = Recommended storage temperature • Non adatto al consumo a crudo. Cuocere accuratamente. • Peso netto = Net weight.
NOR	Opprinnelsesland: New Zealand • Fersk • Slaktedato = Slaughter date • Pakkedato = Pack date • Holdbar til = Use by • Anbefalt oppbevaringstemperatur = Recommended storage temperature • Må ikke spises rå. • Nettovekt = Net weight.
PRT	Criação/Abate/Origem: Nova Zelândia • Fresco • Data de Produção/Abate = Production/Slaughter date • Data de embalagem = Pack date • Data de validade - Use by • Conservar a = Maintain at • Impróprio para ser consumido cru. Cozinhar bem. • Peso líquido = Net weight
ESP	Origen: Nueva Zelanda • Refrigerado • Fecha de sacrificio = Slaughter date • Fecha de envasado = Pack date • Fecha de caducidad = Use by • Temperatura de conservación recomendada = Recommended storage temperature • No apto para su consumo en crudo. Cocinar completamente. • Peso neto = Net weight.
SWE	Ursprung: Nya Zeeland • Färsk • Slakt = Slaughter date • Packat = Pack date • Använd före - Use by • Rekommenderad förvaringstemperatur = Recommended storage temperature • Ej lämplig för rå konsumtion. Tillagas väl. • Nettovikt = Net weight.

